

SPECIFICATIONS

**VITA BELLA
PULLS**

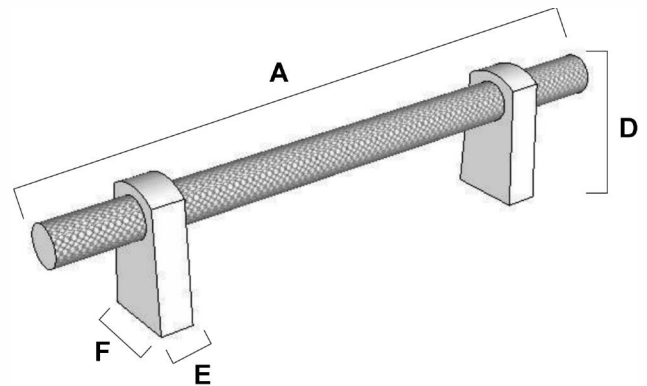
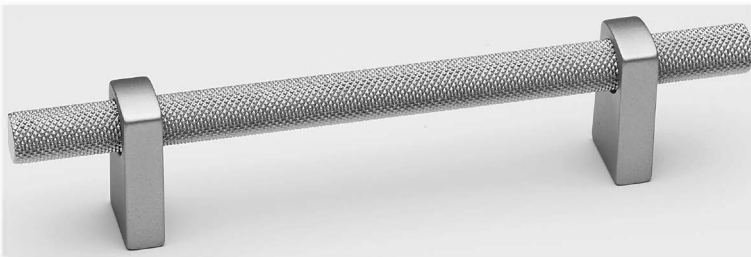

FEATURES

Transitional styling
Multiple finishes
Concealed installation

WARRANTY

Limited lifetime

FINISHES

Matte Black (MB)
Champagne (CHP)
Matte Nickel (MN)
Champagne/Matte Black (CHP/MB)
Matte Nickel/Matte Black (MN/MB)

MATERIAL

Aluminum

Item#	A	B	C	D	F (W)
D2901-18	20 3/4"	18"	5/8"	2-1/8"	63/64"

KEY:

- A - Overall Length
- B - Center to Center
- C - Width
- D - Projection
- E - Mount Length
- F - Mount Width

NOTE: Dimensions and specifications are subject to change without notice.